

Data Mining Laboratory

<http://datalab.snu.ac.kr>



서울대학교
SEOUL NATIONAL UNIVERSITY

Methods and Applications for Data Mining and Machine Learning (AI)

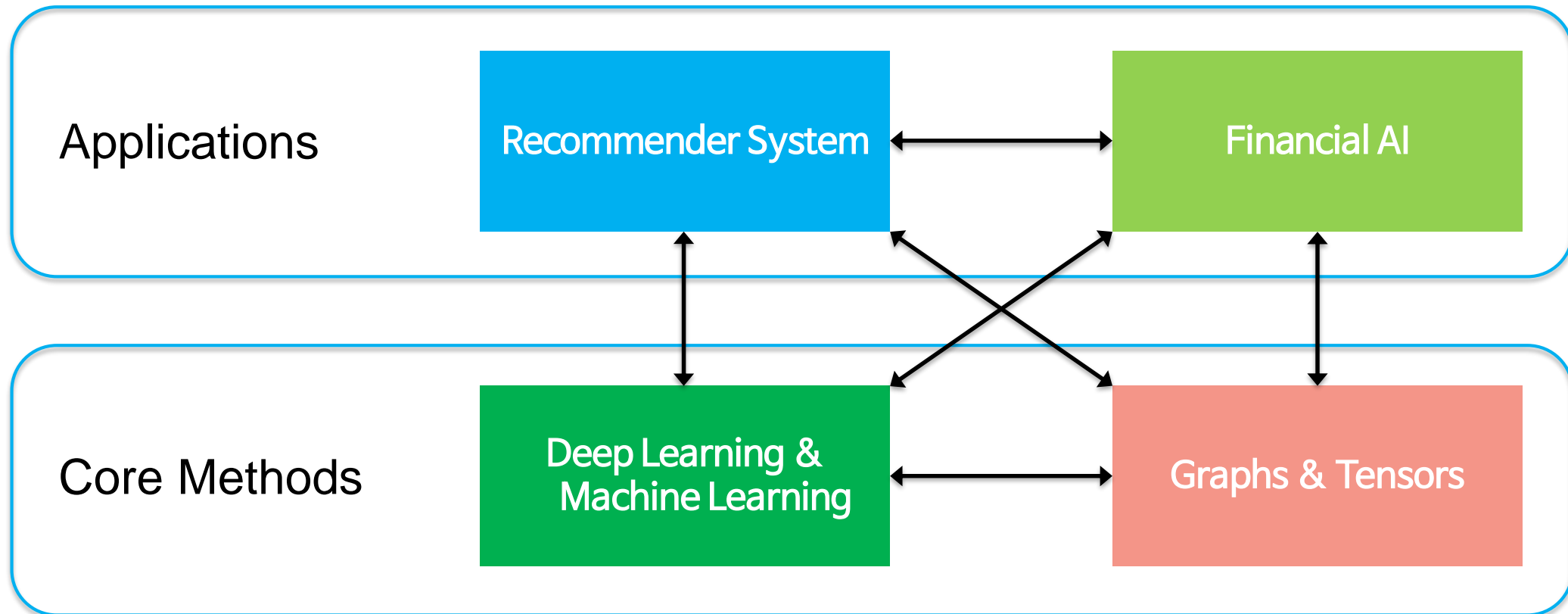

All topics are tightly related

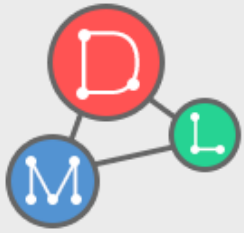

Data Mining Laboratory

http://datalab.snu.ac.kr



서울대학교
SEOUL NATIONAL UNIVERSITY

Recommender System

- Diversified recommendation
- Sequence recommendation
 - Video and news recommendation
- Active recommendation

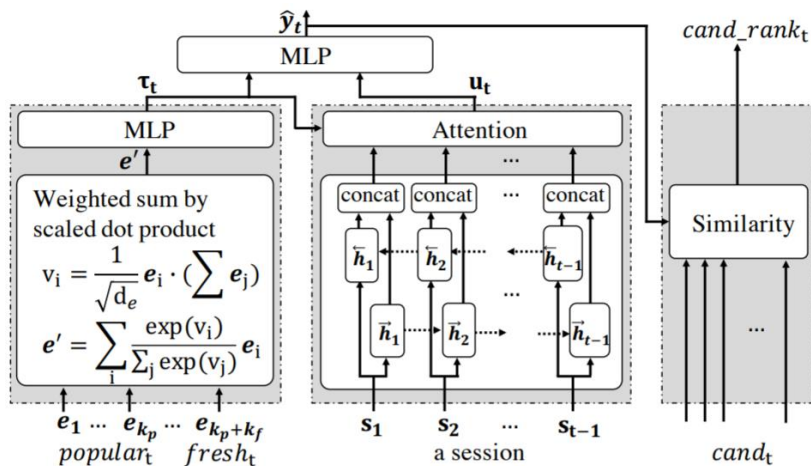

Accurate News Recommendation Coalescing Personal and Global Temporal Preferences (PAKDD'20 **Best Student Paper**)

Financial AI

- Time series prediction
- Stock price prediction
- Portfolio management and trading strategy

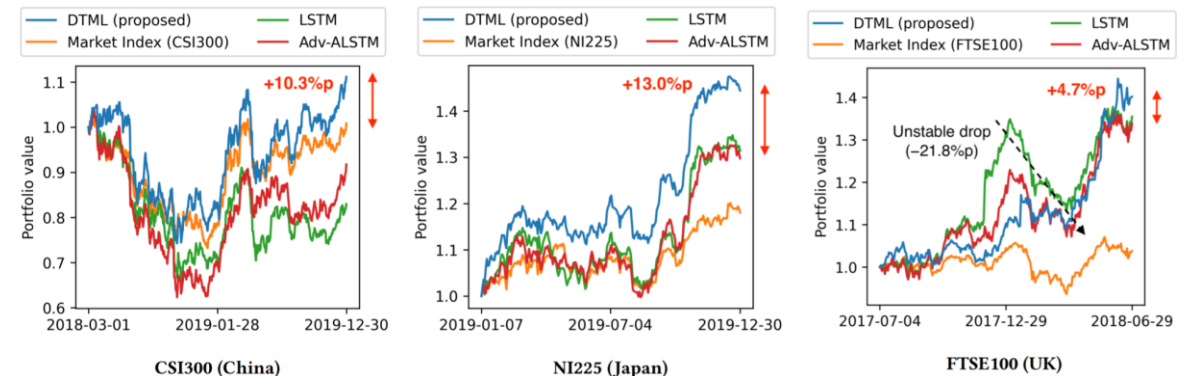

Accurate Multivariate Stock Movement Prediction via Data-Axis Transformer with Multi-Level Contexts (KDD'21)

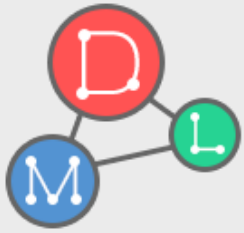

Data Mining Laboratory

http://datalab.snu.ac.kr



서울대학교
SEOUL NATIONAL UNIVERSITY

Deep Learning & Machine Learning

- Fast and adaptive inference
 - Model compression and online learning
- Fast and adaptive learning
 - AutoML and Transfer Learning
- Novel application: e.g., anomaly detection

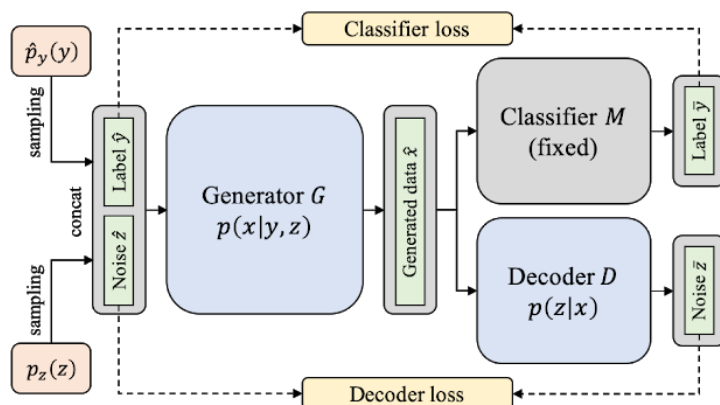

Graphs and Tensors

- Graph mining
 - Ranking, link prediction, relation inference, knowledge graph analysis, and graph summary
- Graph neural network
 - Node classification and representation learning
- Scalable tensor and graph analysis

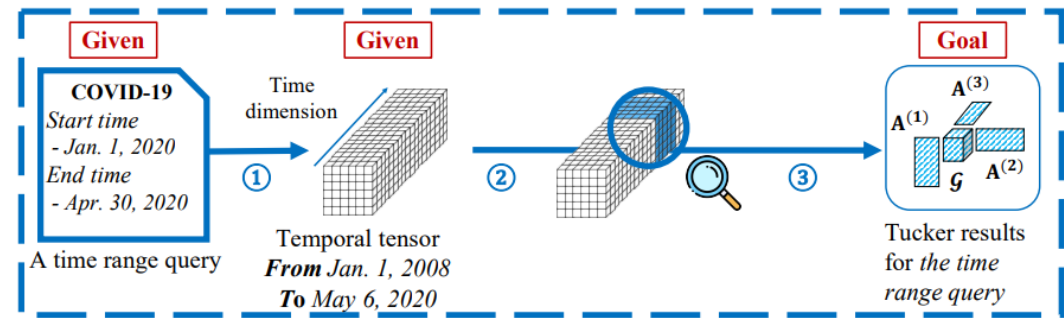

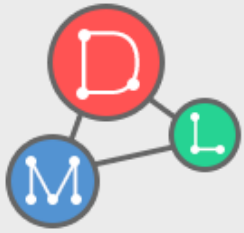

Data Mining Laboratory

<http://datalab.snu.ac.kr>



서울대학교
SEOUL NATIONAL UNIVERSITY

최근 연구 실적

- 데이터 마이닝, 기계 학습 분야 세계 선도
- 2017-현재, 국제 최우수/우수 학회 (KDD, NeurIPS 등), SCI 저널에 50편 이상 발표
 - 데이터 마이닝, AI, 빅데이터 최우수 학회
 - KDD, WWW, ICDM, ICDE, NeurIPS, IJCAI 등
- Best Paper Awards
 - 2022, ICDE Best Research Paper Award
 - 2021, KDD Best Research Paper Award (데이터마이닝/AI 분야 국제 최우수 학회로, 대한민국 최초 수상)
 - 2020, PAKDD Best Student Paper Award
 - 2018, ICDM 10-year Best Paper Award (대한민국 최초)

연구실 구성원 및 진로

- 2022 재학생: 박사 3명, 석박통합 16명, 석사 3명
- 졸업생 진로: 교수, 스타트업 창업/입사, 대기업, 연구소 등

수상 실적

- 우수한 연구 실적에 기반한 여러 수상 실적
- 2020-2021, 울촌 AI Star Fellowship
- 2021, Naver Ph.D. Fellowship
- 2020-2021, Qualcomm Innovation Fellowship
- 2020, MS 주최 뉴스 추천 세계 대회 수상
- 2019, Google Ph.D. Fellowship (ML)
- 삼성 휴먼테크 논문 대상 (7년 연속 수상)
- 2018-2022, 최우수 박사/석사/학사 학위 논문상 (SNU CSE)
- 2018, 2021, BK21 Plus 공과대학 우수 연구상

연구실 Contact

- Professor *U Kang* (ukang@snu.ac.kr)
- Lab Manager *Jun-Gi Jang* (elnino9158@gmail.com)